

SUGAR MACHINE CHAINS

SPECIAL CHAIN SERIES

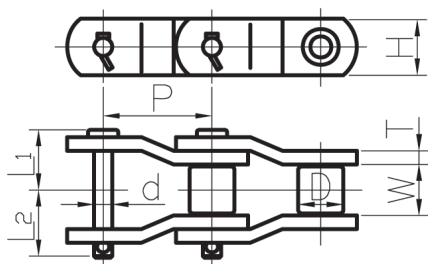

8 Chain

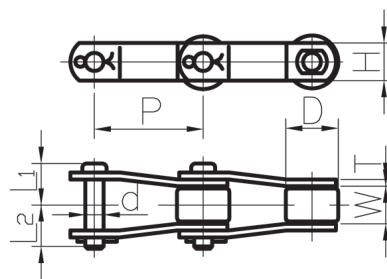

9 Chain

Chain No.	Type	Pitch	Roller		Pin			Link Plate		Ultimate tensile strength	Weight Kg/m
		P mm	D mm	W mm	d mm	L1 mm	L2 mm	T mm	H mm	Q kg	q kg/m
SS40H	8	78.11	31.75	18.1	15.88	40.05	46.65	8.0	38.0	19500	10.2
SS124H	8	103.20	44.45	49.1	22.23	57.00	66.00	12.7	54.0	57000	22.4
SS266	8	103.20	44.45	49.2	22.23	57.00	66.00	12.7	54.0	54000	22.5
SS1113	9	102.60	50.80	37.5	17.50	38.00	45.00	6.3	38.1	9500	10.2
SS1124	9	101.60	50.80	32.0	12.70	37.70	42.80	7.9	38.1	10000	11.0
SS1125	9	101.60	50.80	32.6	17.50	39.50	45.10	7.9	44.5	15500	12.7
SS1130	9	152.40	63.50	37.6	19.05	38.50	45.60	6.3	50.8	14000	12.8
SS2184	9	152.40	76.20	34.9	22.23	44.00	53.00	9.5	50.8	34700	18.4

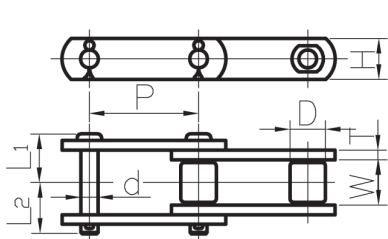

10 Chain

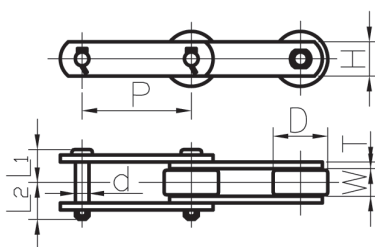

11 Chain

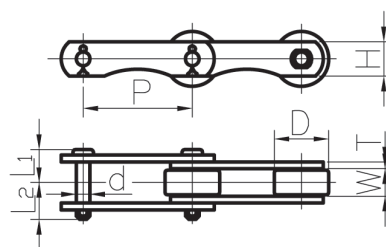

12 Chain

Chain No.	Type	Pitch	Roller		Pin			Link Plate		Ultimate tensile strength	Weight Kg/m
		P mm	D mm	W mm	d mm	L1 mm	L2 mm	T mm	H mm	Q kg	q kg/m
SS205	10	78.11	31.80	37.1	15.88	40.50	47.50	7.9	38.1	9900	10.0
SS1131	11	152.40	76.20	38.1	18.94	46.70	51.60	10.0	50.8	19200	20.5
SS2124	12	152.40	69.80	40.0	19.05	46.10	53.60	9.5	52.9	12500	26.0
SS2188	11	101.60	44.45	33.85	15.88	39.90	46.10	7.9	41.3	11400	11.0
SS2315	11	228.60	76.20	43.0	22.00	49.00	58.00	9.5	63.5	28000	18.3

ATTACHMENT FOR SUGAR MACHINE CHAINS

SPECIAL CHAIN SERIES

Dimension Diagram of A22 or A42 Attachment

Atta. No.	Chain No.	Dimensions						Weight Kg/m
		B	C	F	E	O	T	
A22	SS1125	50.8	54.0	72.3	38.1	16.70	12.7	15.9
A42	SS1113	50.8	60.3	80.3	49.5	16.67	13.0	12.4
A42	SS1124	50.8	54.0	71.5	42.0	16.67	12.7	12.7
A42	SS1130	76.2	67.0	82.6	44.5	16.70	16.0	19.2
A42	SS2184	76.2	66.7	92.5	50.8	17.50	15.0	20.5

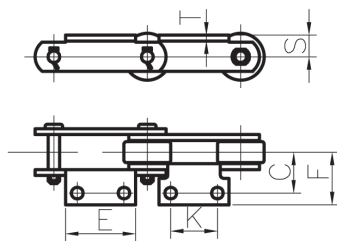
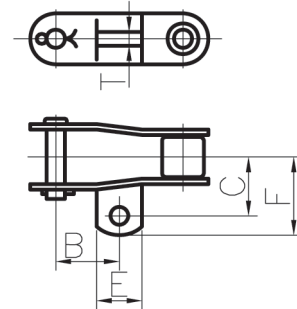

A2 Attachment

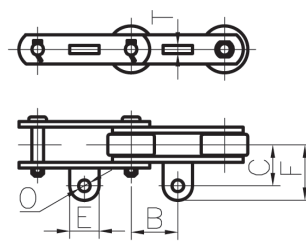

A42 Attachment

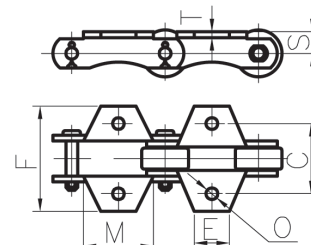

K1 Attachment

Dimension Diagram of A2, A42, K1 Attachment

Atta. No.	Chain No.	Dimensions									Weight Kg/m
		S	B	C	F	K	E	M	O	T	
A2	SS2315	45.0	-	76.6	105.5	139.7	178.0	-	13.5	9.5	22.3
A42	SS1131	-	76.2	66.0	91.4	-	50.8	-	17.5	16.0	20.5
K1	SS2124	41.5	-	111.0	146.0	-	E1 45.0 E 65.0	120.0	16.0	9.5	34.4

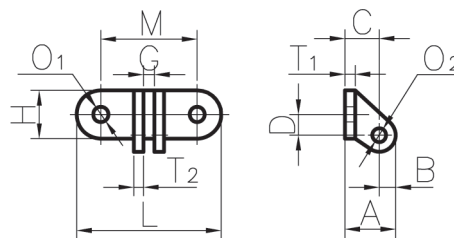

Dimension Diagram of Flight Wing Attachment (C Type)

Atta. No.	Dimensions												Weight Kg/m
	A	B	C	D	G	H	L	M	O1	O2	T1	T2	
0C	49.1	19.0	30.1	20.6	14.3	44.5	111.0	84.1	11.1	16.7	7.9	7.9	0.44
1C	62.5	22.9	39.6	25.4	14.3	50.8	127.0	88.9	14.0	17.0	7.9	9.5	0.5
17C	50.0	15.0	35.0	27.8	11.1	48.0	111.0	76.2	15.0	11.1	8.0	8.0	0.5

ATTACHMENT FOR SUGAR MACHINE CHAINS

SPECIAL CHAIN SERIES

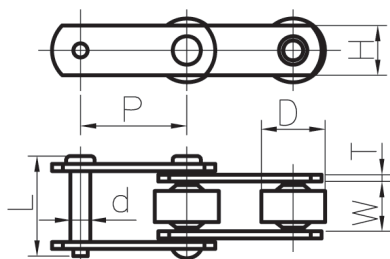

Type A Chain

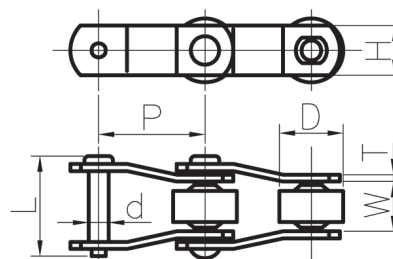

Type B Chain

CHAINS FOR SUGAR PLANT

Chain No.	Type	Pitch	Roller		Pin		Link Plate		Ultimate tensile strength	Weight per meter	Available Attachment Number			
			D	W	d	L	H	T	Q	q	A2	K2	AS2	AS20
			mm		mm		mm		mm		Kg	kg/m		
0904	A	101.6	50.8	29.4	17.5	79.4	44.5	7.9	18150	16.07	O	O	O	O
0906	A.B	152.4	69.9	36.5	19	95.3	50.8	9.5	18150	16.67	O	O	O	O
09060	A.B	152.4	69.9	36.5	19	95.3	50.8	9.5	27200	16.67	O	O	O	O
09061	A.B	152.4	69.9	36.5	19	95.3	57.2	9.5	38600	17.86	O	-	O	-
SS600	B	152.4	69.9	36.5	22.2	100	58.4	9.5	45400	Attachment only	-	O	-	-
09063	A	152.4	76.2	36.5	22.8	101.6	61.9	10.3	63500	-	-	O	-	-

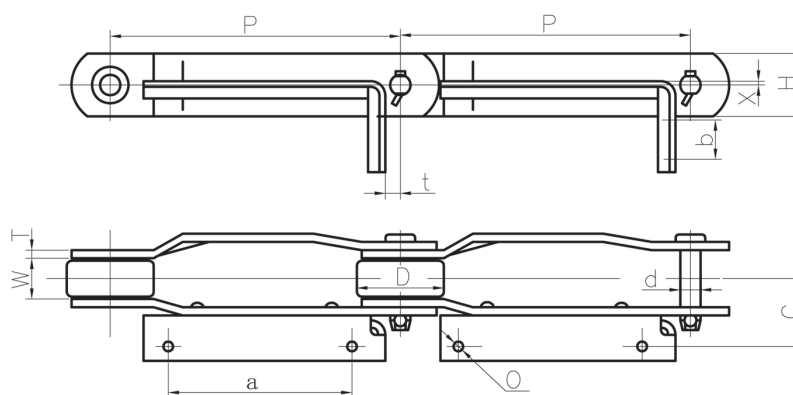

CHAINS FOR TABACOO BAKING MACHINE

Chain No.	Pitch	Roller Dia	Pin dia.	Inside Width	Height of Plate	Thick. of Plate	Attachment Dimensions						Ultimate tensile strength
	P	D	d	W	H	T	a	b	c	o	t	x	Q
	mm	mm	mm	mm	mm	mm	mm	mm	mm	mm	mm	mm	KN
SL200	200	50	12	24.1	30	6	130	30	41.6	8	12.7	2.5	130
SLKG232	200	50	12	24.5	30	6	127	27	43.5	7	12.7	2.5	130
SLKG235	200	50	14	24.5	35	6	127	27	43.5	7	12.7	2.5	160
SLKG275	200	60	15.9	28	45	6	127	27	46.75	7	12.7	2.5	190